

SWIM COURSE

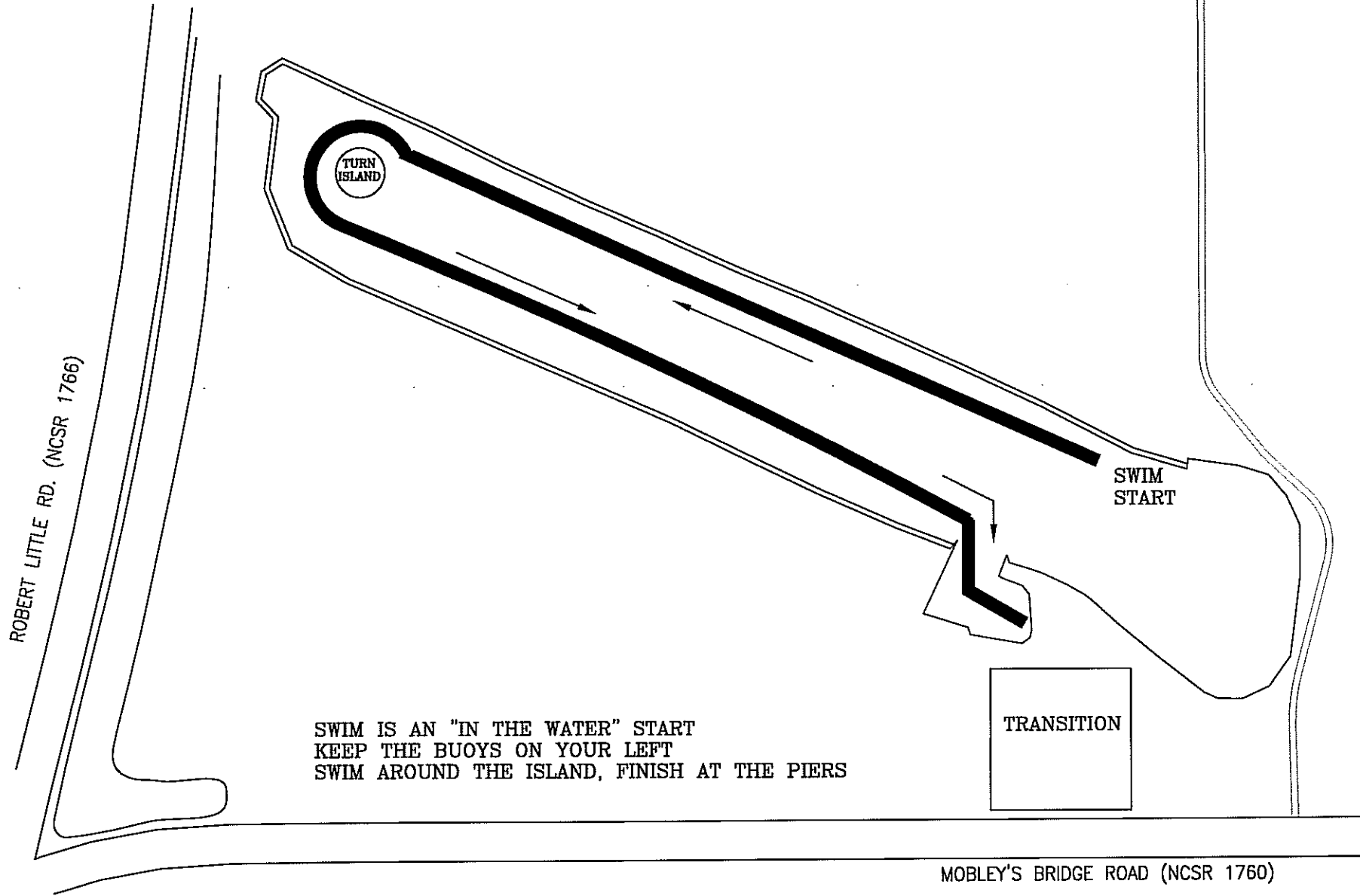

TRANSITION AREA

LAKE

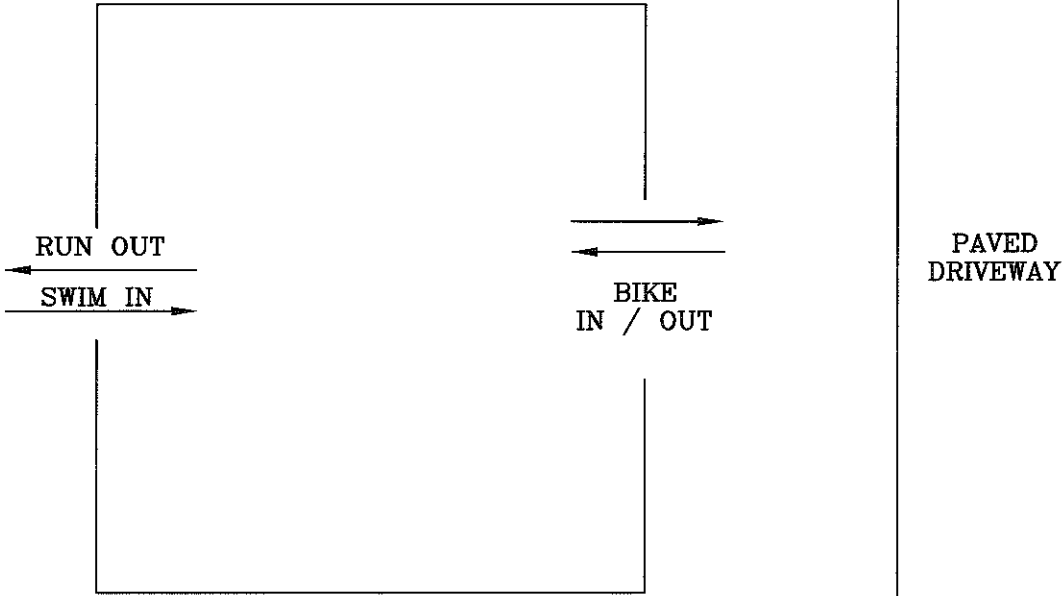

MOBLEY'S BRIDGE ROAD (NCSR 1760)

BIKE COURSE

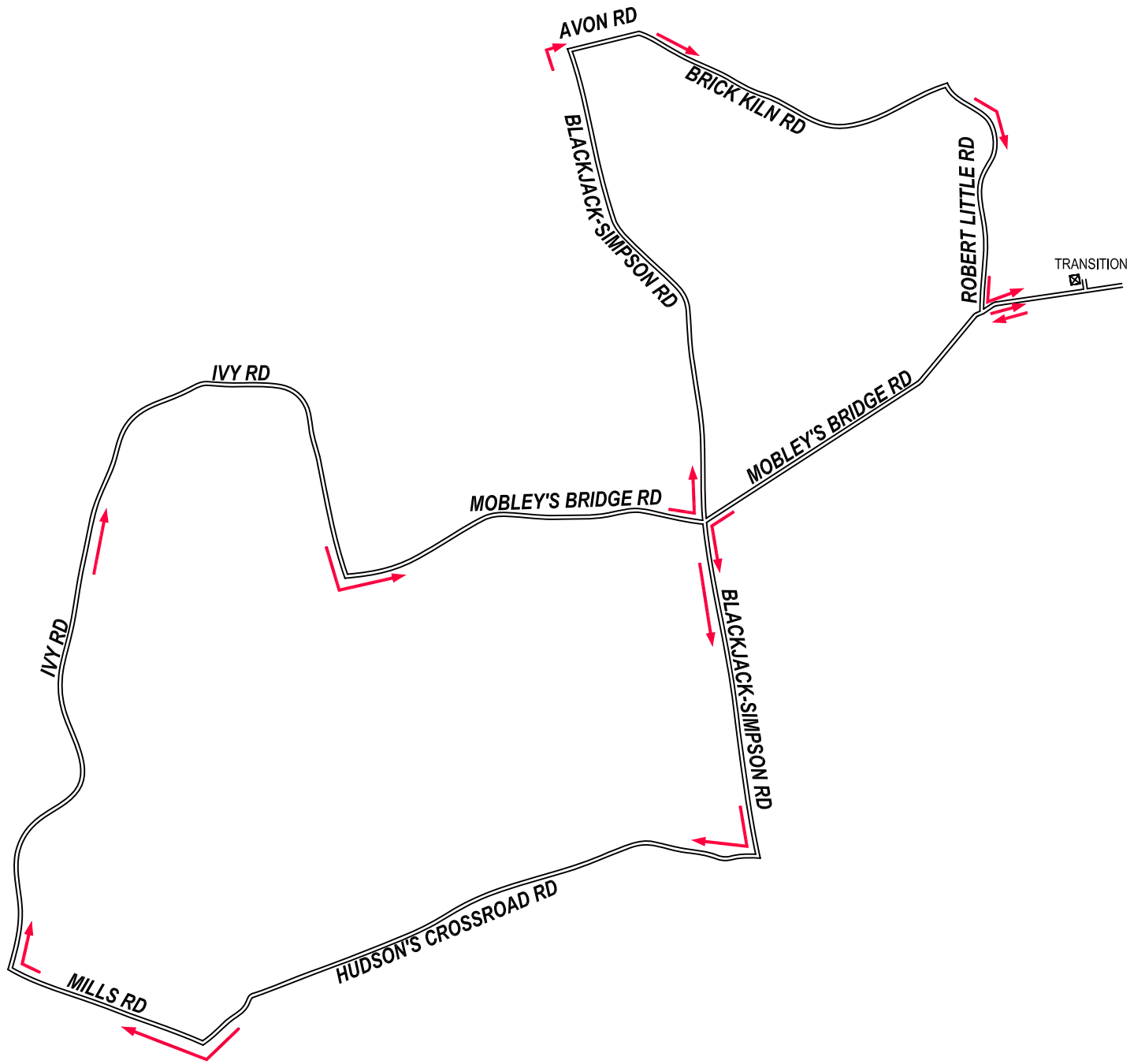

RUN COURSE

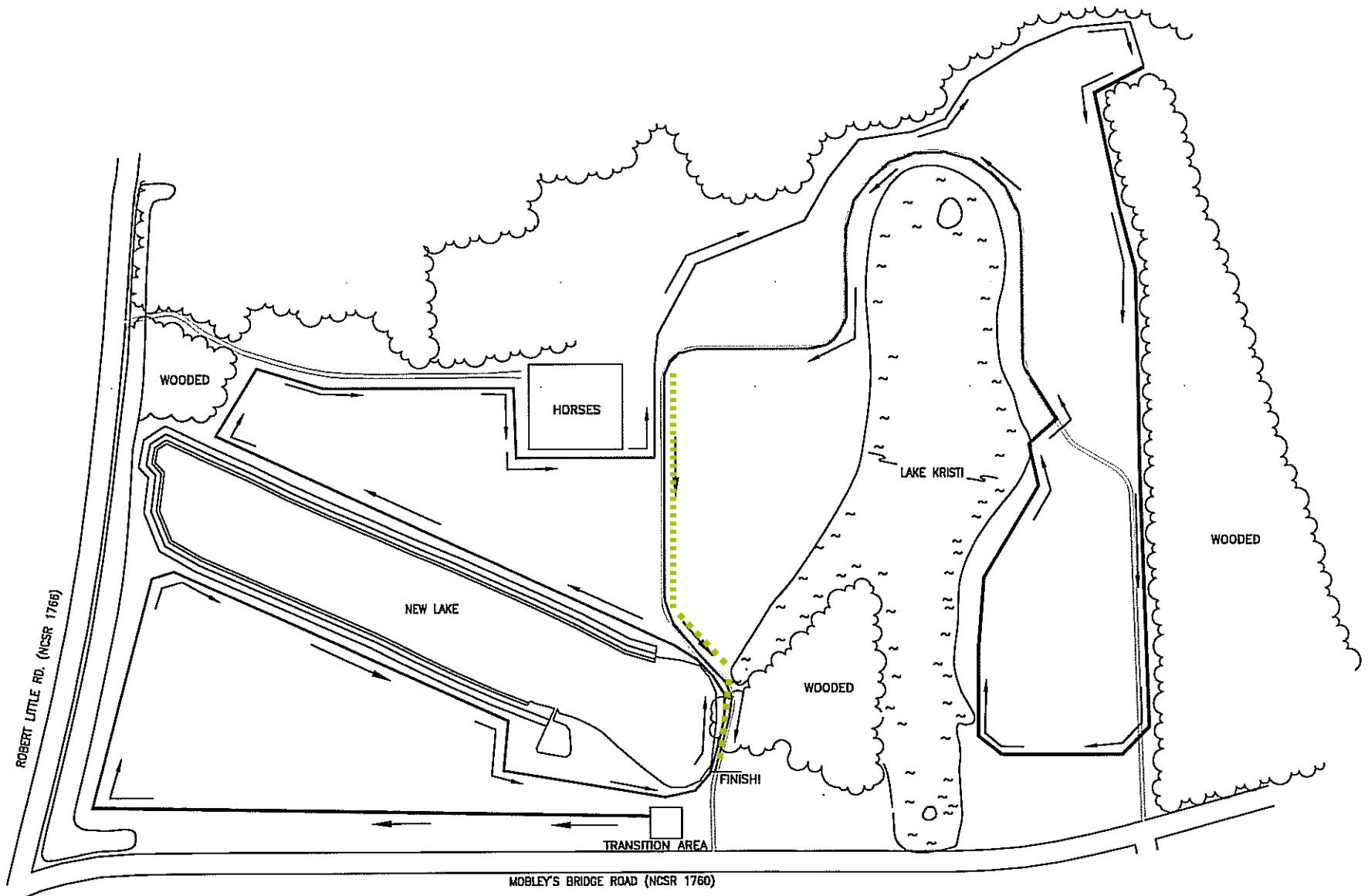

SITE SET-UP

REGISTRATION
TENT

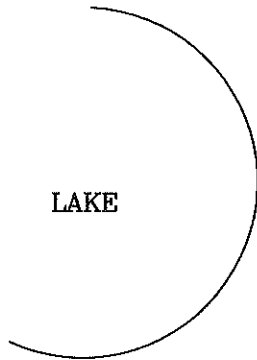
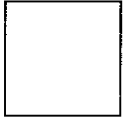

LAKE

FINISH
LINE

EMERGENCY
EGRESS

PAVED
DRIVEWAY

FOOD TENT

EMT TENT

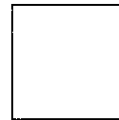

MOBLEY'S BRIDGE ROAD (NCSR 1760)